



**Model 560-5217
AC/DC Power Supply
Manual**

SECTION ONE

- 1. FUNCTIONAL DESCRIPTION
 - 1.1. PURPOSE OF EQUIPMENT
 - 1.1.1. PHYSICAL SPECIFICATIONS
 - 1.1.2. ENVIRONMENTAL SPECIFICATIONS
 - 1.1.3. POWER SUPPLY SPECIFICATIONS
 - 1.1.4. FUNCTIONAL SPECIFICATIONS
 - 1.2. CERTIFICATIONS

SECTION TWO

- 2. INSTALLATION AND OPERATION
 - 2.1. HOT-SWAPPING
 - 2.2. REMOVAL AND INSTALLATION
 - 2.3. SETUP

SECTION THREE

- 3. THEORY OF OPERATION
 - 3.1. GENERAL INFORMATION
 - 3.2. HARDWARE DESCRIPTION
 - 3.3. DETAILED DESCRIPTION
 - 3.3.1. AC INPUT FILTER
 - 3.3.2. AC-to-DC POWER SUPPLY
 - 3.3.3. OR-ING DIODES
 - 3.3.4. STATUS INDICATION
 - 3.3.5. BACKPLANE FAULT OUTPUT

SECTION ONE

1. FUNCTIONAL DESCRIPTION

1.1 PURPOSE OF EQUIPMENT

The TrueTime Model 560-5217 power supply has a 100-240 VAC input and a DC input (36 to 72 VDC) that are used to power the 56K chassis. The power supply works in conjunction with the 560-1239-1 rear power entry module that provides the input connector, chassis ground lug, and fuse.

The wide range AC input is converted to 56 VDC and is power OR'ed with the DC input using on-card diodes. The OR'ed power output is connected to the 56K chassis backplane for distribution. The 56 VDC from the AC power supply provides primary power to the 56K chassis when the DC input is less than 56 VDC.

The power OR-ing diodes also allow the 560-5217 power supply to be used in a redundant configuration with another like AC supply or alternate DC power source. In this configuration, if one power supply in the chassis fails, the other takes over. If both supplies are functioning, the highest voltage supply delivers power to the 56K chassis.

1.1.1 PHYSICAL SPECIFICATIONS

Dimensions: 1.6" w x 4.4" h x 8.66" d
(4 cm x 10 cm x 22 cm)
Weight: Approximately 2 pounds (1 kg)

1.1.2 ENVIRONMENTAL SPECIFICATIONS

Operating Temp: 0° to +50°C
Storage Temp: -40° to +85°C
Humidity: Up to 95% relative, non-condensing
Cooling Mode: Convection

1.1.3 POWER SUPPLY SPECIFICATIONS

AC Input Voltage: 100-240 VAC (continuous), 47-63 Hz
AC Input Power: 135 W maximum
Output Voltage: 56 VDC ±5%
DC Input Voltage: 36-72 VDC
AC Fuse* 2 Amp 3AG SLO-BLO (100-120 VAC range)
AC Fuse* 1 Amp 3AG SLO-BLO (200-240 VAC range)
DC Fuse* 5 Amp 3AG SLO-BLO

* On 560-1239-1 power entry module

AC Power Supply Maximum Output Power:

INPUT	AMBIENT	AIRFLOW	OUTPUT
100-240 VAC	50°C	CONVECTION	90 W

1.1.4 FUNCTIONAL SPECIFICATIONS

1.1.4.1 INPUT POWER CONNECTOR

See Chassis manual.

1.1.4.2 FRONT PANEL "48VDC" TEST POINTS

DC+	DC Input (positive)
DC-	DC Input (negative)
AC+	AC 56 VDC (positive)
AC-	AC 56 VDC (negative)
Isolation:	6.8 kΩ

1.1.4.3 FRONT PANEL STATUS INDICATORS

DC STATUS	RED/GREEN LED (Green or Off)
AC STATUS	RED/GREEN LED (Green or Off)

1.1.4.4 CARD COMPATIBILITY

Location:	Slot 18/19 or 20/21
Compatibility:	560-1239-1 AC/DC Power Entry Module

1.2 CERTIFICATIONS

1.2.1 CE COMPLIANCE / UR AND C-UR RECOGNITION

The 560-5217 power supply is CE compliant, and UR and C-UR recognized.

SECTION TWO

2. INSTALLATION AND OPERATION

2.1 HOT-SWAPPING

All cards input cables and output cables are hot-swappable. It is not necessary to remove chassis power during insertion or removal of load or power assemblies. The system is designed to protect against permanent damage and minimize any temporary effects of hot-swapping.

2.2 REMOVAL AND INSTALLATION

CAUTION: Individual components on this card are sensitive to static discharge. Use proper static discharge procedures during removal and installation.

For proper operation, the Power Supply **MUST** be installed in a slot with a matching rear Power Entry Module.

To remove the power supply card, loosen the captive retaining hardware at the top and bottom of the assembly then, firmly pull on the handle at the bottom of the card. Slide the card free of the chassis. Refer to the SETUP section for any required switch settings or set them identically to the card being replaced. Reinstall the power supply in the chassis and slide it in slowly, avoiding contact between adjacent card front panel, until it mates with the connector. Seat card firmly to avoid contact bounce. Secure the retaining screws at the top and bottom of the assembly.

2.3 SETUP

Setup of this power supply involves an on-board 4-position switch that provides control of the front panel Status LEDs and the card's alarm conditions. SW1 has the following functions:

SW1-1	"AC_GRN"
ON	Enables the front panel AC STATUS LED to illuminate green when the AC supply has power.
OFF	Disables the AC STATUS LED green indication when the AC supply has power (LED off). Provides the same indication (none) as older 56K power supplies (560-5149).

SW1-2	"AC_EN"
ON	Enables AC power supply fault reporting to the 560-5170 Fault Monitor/CPU card. No power = alarm.
OFF	Disables AC power supply fault reporting to the 560-5170 Fault Monitor/CPU card. No power = no alarm.

SW1-3	"DC_EN"
-------	---------

ON	Enables DC power supply fault reporting to the 560-5170 Fault Monitor card. No power = alarm.
OFF	Disables DC power supply fault reporting to the 560-5170 Fault Monitor card. No power = no alarm.
SW1-4	“DC_GRN”
ON	Enables the front panel DC STATUS LED to illuminate green when the DC supply is available.
OFF	Disables the DC STATUS LED green indication when the DC supply has power (LED off). Provides the same indication (none) as older 56K power supplies (560-5149).

The front panel AC and DC STATUS LEDs will illuminate red when the associated power source is off (and backplane power is available from another source).

The factory defaults for SW1 is all ON – both AC and DC Status LEDs indicate green when the associated power is on and either AC or DC loss of power will cause a fault condition.

SECTION THREE

3. THEORY OF OPERATION

3.1 GENERAL INFORMATION

This section contains a brief description of the circuits on the 560-5217 power supply card.

3.2 HARDWARE DESCRIPTION

The power supply utilizes an AC Input Filter located on the 560-1239-1 Power Entry Module, AC-to-DC power supply, power OR-ing diodes, solid state relays for LED Status and power supply fault reporting, and the 4-position SW1 control switch.

3.3 DETAILED DESCRIPTION

3.3.1 AC INPUT FILTER

The input filter consists of an electromagnetic interference (EMI) filter. The filter reduces common and differential mode EMI conducted into and/or out of the chassis. This filter is located on the Power Entry Module located at the rear of the chassis mid-plane, directly behind the associated power supply.

3.3.2 AC-to-DC POWER SUPPLY

The wide range AC power supply provides a 56 VDC output. This output may be the primary power source for the 56K chassis.

3.3.3 OR-ING DIODES

Power is delivered to the backplane via 10 Amp diodes -- one diode in the AC power supply leg and one in the DC input leg. This connects the two power sources in a primary/secondary configuration, where the source with the highest voltage provides power to the 56K chassis.

The front panel test points (marked as 48VDC DC and AC) connect to these power sources and provide a means to measure the sources rather than the voltage on the 56K backplane.

3.3.4 STATUS INDICATION

The front panel fault indicators are powered by the backplane power source. This power can be from either the 560-5217 AC or DC source or the AC or DC source from another 560-5217 power supply that has been installed in the 56K chassis to provide

redundancy. When backplane power is available, the LED STATUS indicators will illuminate red when the corresponding power source is off. This could be caused by a loss of power at the source, a disconnected power entry power-input cable, a blown power entry fuse, or a failed power supply.

If SW1 switches 1 and 4 are on, the LED STATUS indicators will illuminate green when the corresponding power source is on. If SW1 switches 1 and 4 are off, the STATUS indicators will be off to indicate that power from both sources is on.

The front panel STATUS LEDs are controlled by solid state relays. Note that the STATUS indicators may activate briefly during a hot-swap or power-up.

3.3.5 BACKPLANE FAULT OUTPUT

Each power supply slot contains a fault output, which can be read by the Fault Monitor CPU. If SW1 switches 2 and 3 (AC_EN, DC_EN) are on, the CPU will respond to a fault from either source by setting all fault status and status register bits HIGH for the chassis slots of the faulting power supply module. The fault alarm signal from either the AC or the DC source can be made inactive by setting the appropriate SW1 switch off.

Solid state relays (and SW1-2 & 1-3) control the fault output. Note that a power supply fault may activate briefly during a hot-swap or power-up.

© TrueTime, Inc. 2002 All Rights Reserved.

PROPRIETARY NOTICE

THIS DOCUMENT, WHETHER PATENTABLE OR NON-PATENTABLE SUBJECT MATTER, EMBODIES PROPRIETARY AND CONFIDENTIAL INFORMATION AND IS THE EXCLUSIVE PROPERTY OF TRUETIME, INC. IT MAY NOT BE REPRODUCED, USED OR DISCLOSED TO OTHERS FOR ANY PURPOSE EXCEPT THAT FOR WHICH IT IS LOANED, AND IT SHALL BE RETURNED UPON DEMAND.

REVISIONS

LTR	DESCRIPTION	DATE	APPROVED
Q2	MODIFIED LAYOUT	07/13/99	
A	FIRST RELEASE WITH UL APPROVAL	11/08/00	MDK
B	ECO 1502	02/27/01	DR
C	ECO 1540	05/31/01	GFZ
D	ECO 1701	03/11/02	FB
E	ECO 1738	05-15-02	<i>[Signature]</i>

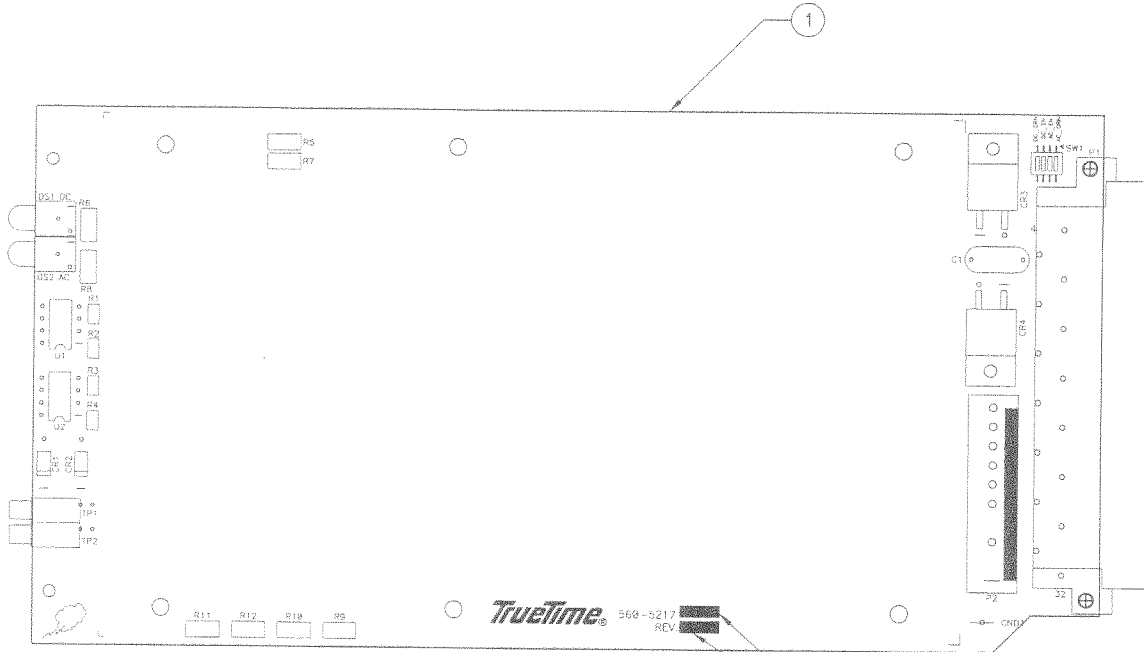

- 4. STAMP DASH NUMBER AND REVISION LEVEL.
- 3. POLARIZED CAPACITORS ARE SHOWN WITH A ROUNDED EDGE INDICATING THE POSITIVE SIDE.
- 2. RESISTOR VALUES IN OHMS, CAPACITORS IN MICRO FARADS.
- 1. ASSEMBLE PER ASSEMBLY REQUIREMENTS DOCUMENT 421-11.

NOTES: UNLESS OTHERWISE SPECIFIED.

FILENAME: 560-5217A
DATE: 05-15-02

 TRUETIME	
APPROVALS	DATE
DRAWN BY BAS	05/12/99
CHECKED BY	
APPROVED BY GFZ	11/09/00
56K POWER SUPPLY ASSY DWG, TOP SIDE	
NEXT ASSY	SIZE CODE IDENT NO. DRAWING NO. REV
	B 560-5217 E
SCALE NONE SHEET 1 OF 3	

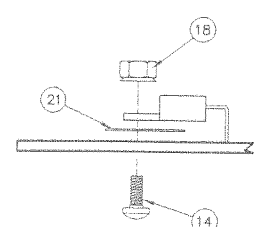
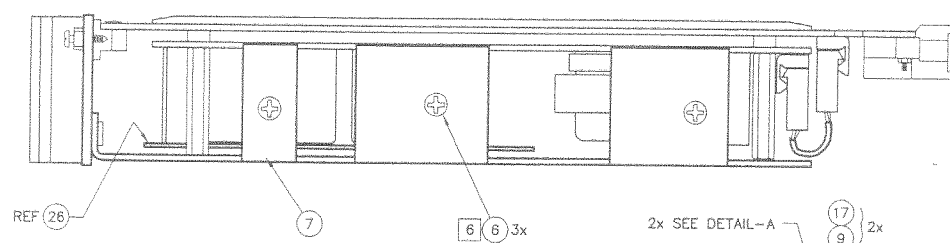

DETAIL-A

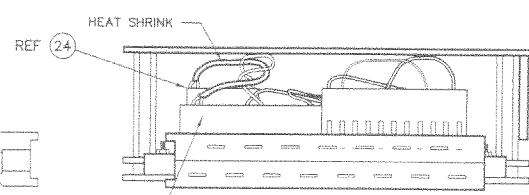
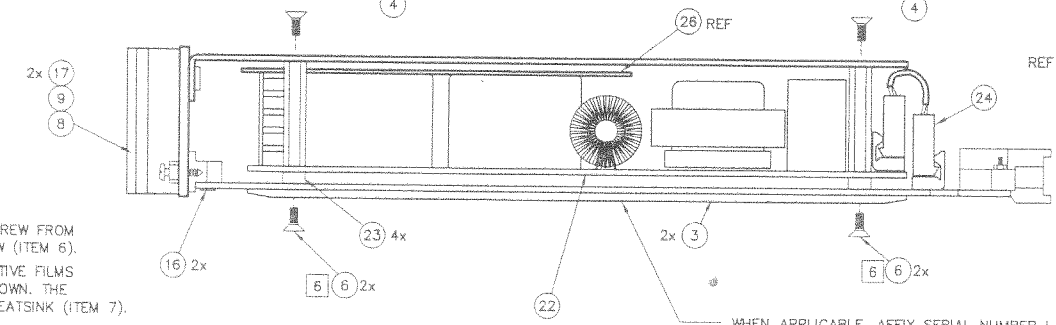
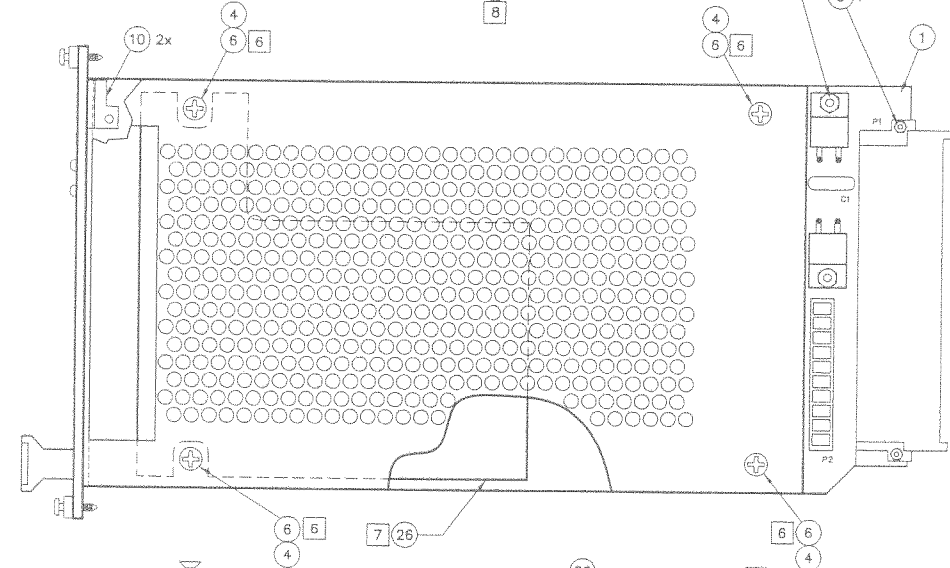
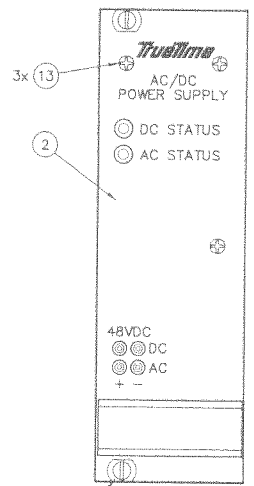

- 8 REMOVE AND DISCARD EXISTING SCREW FROM ITEM 22 BEFORE INSTALLING SCREW (ITEM 6).
 - 7 REMOVE CLEAR AND WHITE PROTECTIVE FILMS FROM ITEM 26 AND INSTALL AS SHOWN. THE BLUE SIDE WILL BE TOWARD THE HEATSINK (ITEM 7).
 - 6 APPLY LOCTITE TO SCREW THREADS.
 - 5 10 PIN CONNECTOR WITH ATTACHED HEAT SHRINK TUBING CONNECTS TO P1.
- NOTES: (CONT.)

WHEN APPLICABLE, AFFIX SERIAL NUMBER LABEL HERE

FILENAME: 560-5217B
DATE: 05-15-02

		SIZE	CODE IDENT NO.	DRAWING NO.	REV
		B		560-5217	E
SCALE NONE		SHEET 2 OF 3			

TrueTime, Inc.
Single Level Bill of Material Report

Date - 5/15/2002
Time - 14:38.09
Page - 2

Parent Item	Parent Description	Batch Quantity		Bubble		Effective					
Component Item	Component Description	Quantity Per	UM	Seq No	Remarks	Level	Ty	Seq	T	From	Thru
223-144	NUT M2.5	3.00	EA	9		1	S	16.0	P	1/1/2000	12/31/2010
223-181	HOLDER (PB) DIE CAST	2.00	EA	10		1	S	17.0	P	1/1/2000	12/31/2010
223-379	SCREW CAP NP M2.5 X 11	2.00	EA	11		1	S	18.0	P	1/1/2000	12/31/2010
223-464	SLEEVE, STAINLESS	2.00	EA	12		1	S	19.0	P	1/1/2000	12/31/2010
223-500	SCREW PH FH NP M2.5X10	3.00	EA	13		1	S	20.0	P	1/1/2000	12/31/2010
240-004-002	SCREW PH PN SS 4-40X1/4	2.00	EA	14		1	S	21.0	P	1/1/2000	12/31/2010
241-006-005	PH FH SS 6-32X5/8 100 DEG	11.00	EA	6		1	S	23.0	P	1/1/2000	12/31/2010
249-005	SCREW M2.5 X 8	2.00	EA	16		1	S	24.0	P	1/1/2000	12/31/2010
249-007	SCREW SH CH ZN M2.5X12	4.00	EA	17		1	S	25.0	P	1/1/2000	12/31/2010
251-004	NUT KEP SS 4-40	2.00	EA	18		1	S	26.0	P	1/1/2000	12/31/2010
255-006-019	SPCR HEX NYL 6-32X1-3/16	4.00	EA	4		1	S	42.0	P	11/8/2000	12/31/2010
270-006-002A	1/4R X 1/8IN LONG NYLON	4.00	EA	23		1	S	46.0	P	2/27/2001	12/31/2010
272-009	INSULATOR TO-220 SIL PAD	2.00	EA	21		1	S	30.0	P	1/1/2000	12/31/2010
273S-001	TESTPOINT, LOOP, SMT	1.00	EA			1	S	48.0	P	5/15/2002	12/31/2010
282-002	GND1 ADHESIVE LQC-TITE ASSURE	.20	EA		SEE DWG NOTE 6	1	S	32.0	P	1/1/2000	12/31/2010
291-012	THERMAL INTERFACE	1.00	EA	26		1	S	43.0	P	11/8/2000	12/31/2010
372-15RA	CONN 15-P DIN PWR RT ANG	1.00	EA			1	S	33.0	P	1/1/2000	12/31/2010
401-01-01-10C	P1 HEADER 10-P LCKNG W/VOIDS	1.00	EA			1	S	34.0	P	1/1/2000	12/31/2010

Parent Item	Parent Description	Batch Quantity		Bubble							Effective	
Component Item	Component Description	Quantity Per	UM	Seq No	Remarks	Level	Ty	Seq	T	From	Thru	
	P2											
560-1223	GUIDE RAIL FOR DRC P/S	2.00	EA	3		1	S	36.0	P	1/1/2000	12/31/2010	
560-1264	PANEL,POWER SUPPLY AC/DC	1.00	EA	2		1	S	39.0	P	1/1/2000	12/31/2010	
560-1269	CABLE ASSY PWR SUP (DRC)	1.00	EA	24		1	S	44.0	M	11/8/2000	12/31/2010	
560-1271	HEAT SINK, 56K PWR SUPPLY	1.00	EA	7		1	S	45.0	P	11/8/2000	12/31/2010	
560-2217	PCB 56K PWR SUPPLY	1.00	EA	1		1	S	40.0	P	1/1/2000	12/31/2010	